



**John
BOOS**
Since 1887

ITEM #: _____ QTY: _____
 MODEL #: _____
 PROJECT NAME: _____

082818

3601 S. Banker St. Effingham, IL 62401 • P.O. BOX 609 • Ph: (888) 431-2667 • Fax: (800) 433-2667

"3PB" PRO-BOWL COMPARTMENT SINKS 16GA

3 COMPARTMENT - STAINLESS STEEL BASE



FEATURES:

- STANDARD 16GA TYPE 300 STAINLESS STEEL WITH #4 POLISH, SATIN FINISH
- 12" & 14" DEEP BOWLS
- ALL CORNERS, BOTH VERTICAL AND HORIZONTAL, COVERED AT 5/8" RADIUS
- BOTTOMS OF BOWLS FORMED FOR DRAINAGE TO 3-1/2" DIAMETER DIE STAMPED OPENING
- FULL LENGTH **10" HIGH BOXED BACKSPLASH**, WITH 2" RETURN TO WALL AT 45 DEGREE AND 3/4" TURNED DOWN REAR LIP
- 8" ON-CENTER, 1" FAUCET HOLES IN BACKSPLASH
- SOLID STAINLESS STEEL FRONT PANEL, TYPE 300 STAINLESS STEEL WITH #4 POLISH, SATIN FINISH
- ALL OUTSIDE CORNERS OF ASSEMBLY ARE BULLNOSED TO PROVIDE SAFE, CLEAN, AND POLISHED EDGE

MATERIAL:

- BOWLS & TOP: 16GA TYPE 300 STAINLESS STEEL WITH #4 POLISH, SATIN FINISH
- LEGS: 1-5/8" ROUND O.D. STAINLESS STEEL
- BRACING: 1-1/4" ROUND O.D. STAINLESS STEEL
- GUSSETS: STAINLESS STEEL
- FEET: 1" ADJUSTABLE STAINLESS STEEL BULLET FEET



CONSTRUCTION:

- TOP: STAINLESS STEEL SINKS ARE TIG WELDED, EXPOSED WELDS ARE POLISHED TO MATCH ADJACENT SURFACE
- BASE: STAINLESS STEEL BASES, STANDARD K.D.

16GA - "3PB" PRO-BOWL SERIES SINK

12" DEEP	QTY	14" DEEP	QTY
3PB1618		3PB16184	
3PB1620		3PB16204	
3PB18		3PB184	
3PB1824		3PB18244	
3PB20		3PB204	
3PB24 *		3PB244 *	
3PB3024 *		3PB30244 *	

* WITH TWO SETS OF FAUCET HOLES 8" O/C

OPTIONAL ACCESSORIES

DESCRIPTION	QTY
END SPLASHES, R, L, OR BOTH	
FAUCETS	
ADD-A-FAUCETS	
PRE-RINSE UNITS	
LEVEL WASTE	
OVERSHELVES	
POT RACK	

DETAILED SPECIFICATIONS

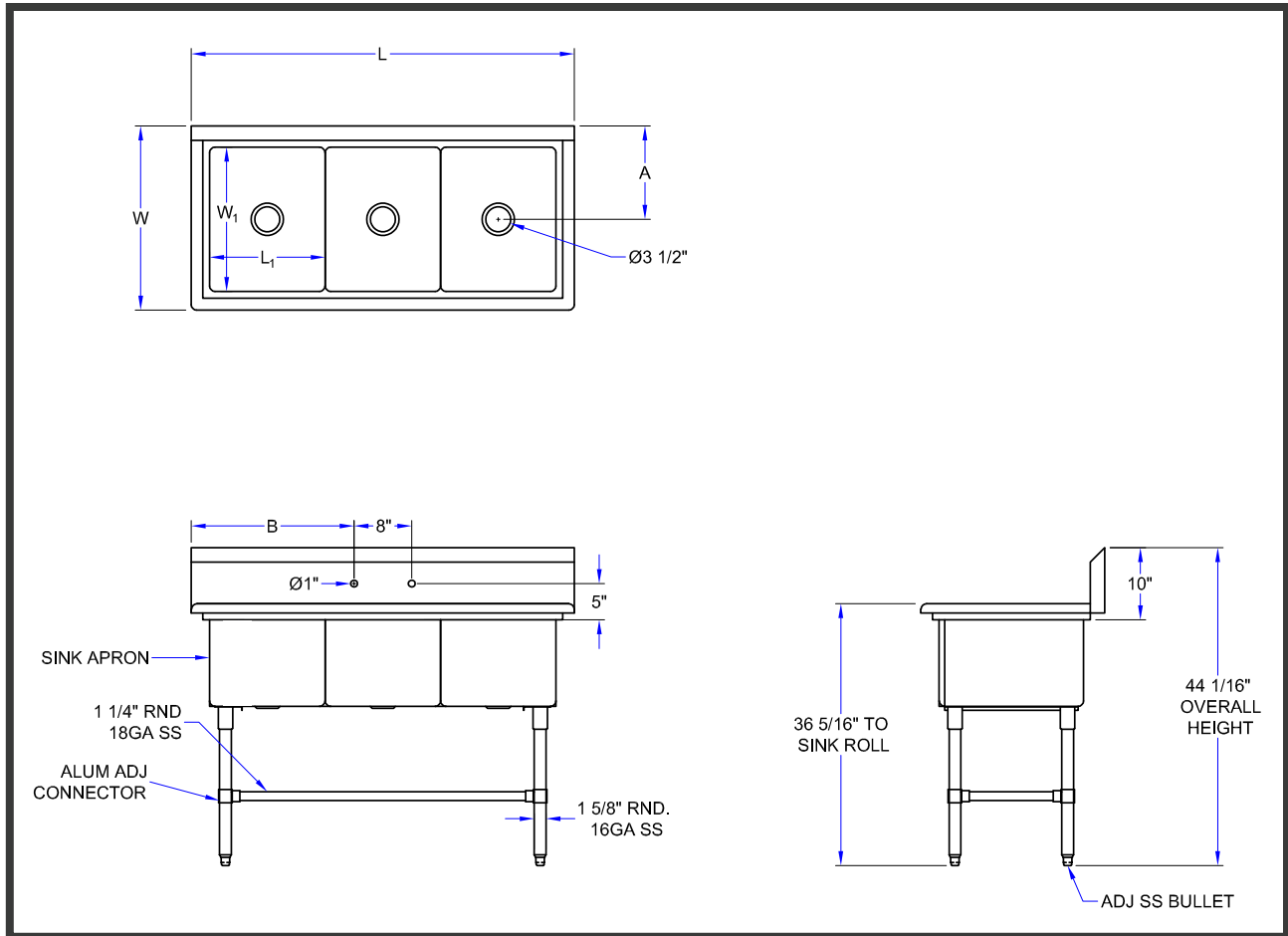

16GA - "3PB" PRO-BOWL SERIES SINK

12" DEEP	14" DEEP	L	W	L1	W1	A	B
3PB1618	3PB16184	53-1/8"	23-1/2"	16"	18"	11-15/16"	22-9/16"
3PB1620	3PB16204	53-1/8"	25-1/2"	16"	20"	12-15/16"	22-9/16"
3PB18	3PB184	59-1/8"	23-1/2"	18"	18"	11-15/16"	25-9/16"
3PB1824	3PB18244	59-1/8"	29-1/2"	18"	24"	14-15/16"	25-9/16"
3PB20	3PB204	65-1/8"	25-1/2"	20"	20"	12-15/16"	28-9/16"
3PB24	3PB244	77-1/8"	29-1/2"	24"	24"	14-15/16"	22-9/16"
3PB3024	3PB30244	95-1/8"	29-1/2"	30"	24"	14-15/16"	28-9/16"

SOME UNITS SHIP UNASSEMBLED FOR REDUCED SHIPPING COST. ALL DIMENSIONS ARE TYPICAL. TOLERANCE +/- .500"

John Boos & Co. is constantly engaged in a program of improving products and therefore reserves the right to change specifications without prior notice.



3601 S. Banker St. • Effingham, IL 62401 • PO BOX 609 • quotes@johnboos.com

www.johnboos.com